



# Assembly Instructions Christos Square Table and Bar Base

Please assemble on a clean and flat surface, such as carpet or cardboard to prevent scratches (do not assemble on your floor). PLEASE NOTE: We've tried to make this table base as easy to assemble as possible. In the unlikely event you have problems putting it together or missing pieces, please contact us. Details below.

You will also need a 19mm deep socket

CHRISBARSQ-BK  
CHRISDINSQ-BK

A 1X Base

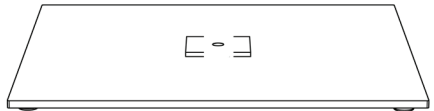

B 1X Table top bracket

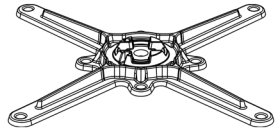

C 1X Column

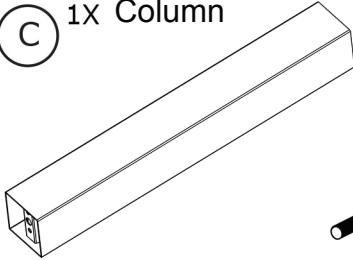

D 1X Central bar

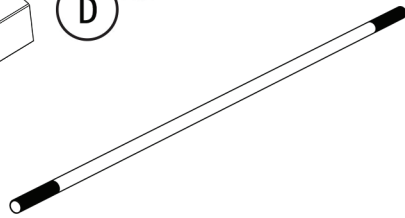

E 2x M12 Nut



F 1X M12 Flange Nut



1 Screw one bolt (E) onto the end of the central bar (D). Feed the bar through the Table top bracket (B) and screw in the 2nd bolt (E)

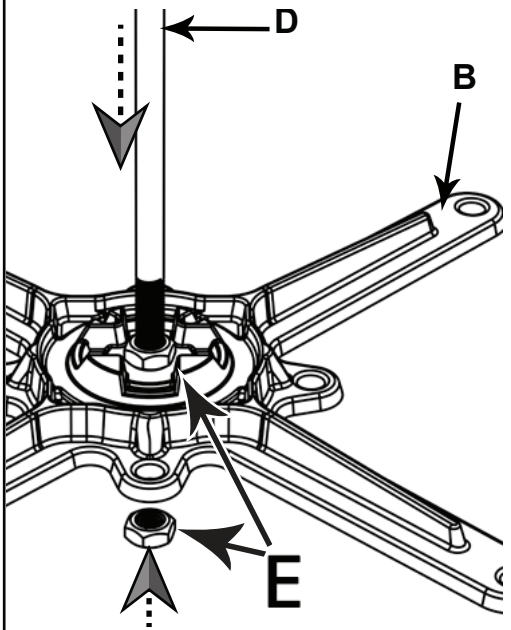

2

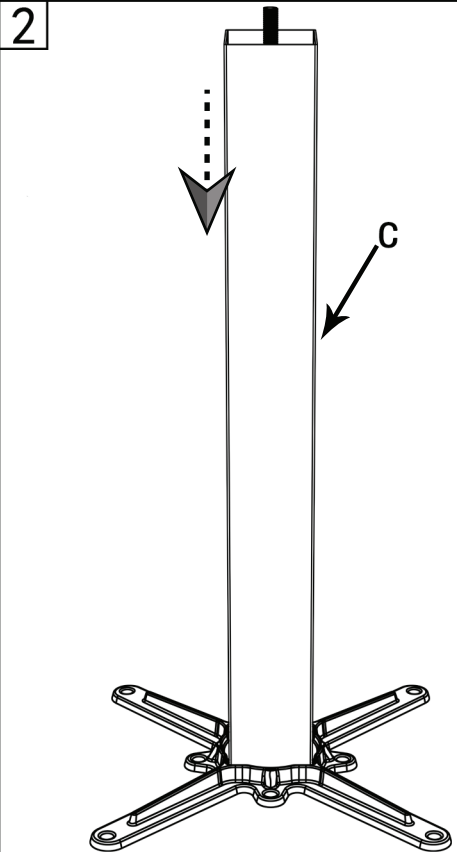

3

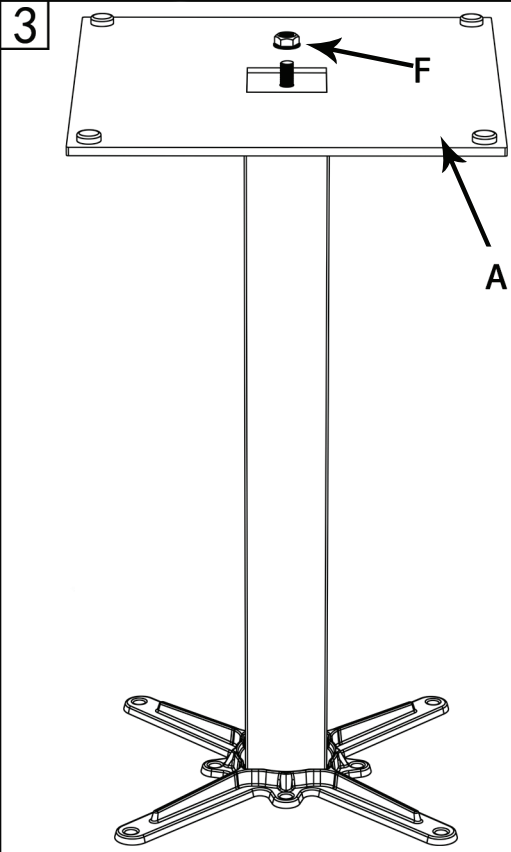

4

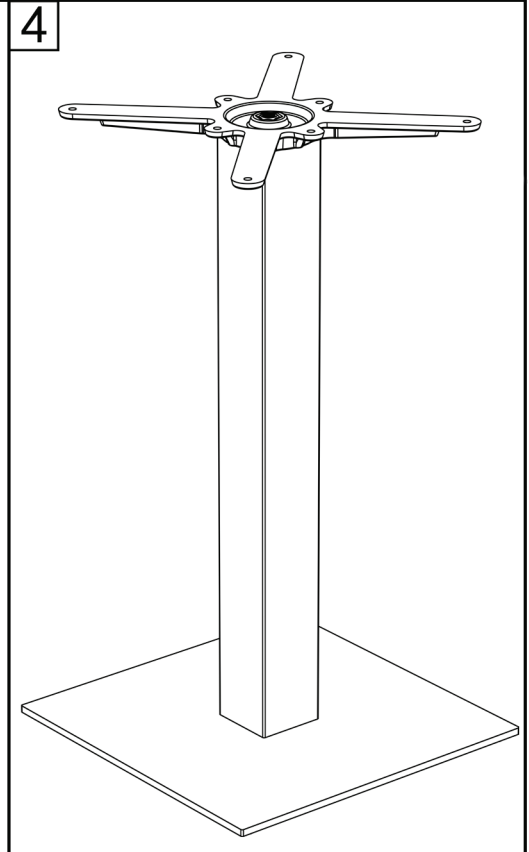

Exclusively distributed in AU and NZ by Chairforce. Thank you for your purchase. To learn more about our products please visit [www.chairforce.com.au](http://www.chairforce.com.au) and [www.chairforce.co.nz](http://www.chairforce.co.nz)  
AU: Call: 08 9436 8570 Email: [customercare@brayco.com.au](mailto:customercare@brayco.com.au)  
NZ: Call: 09 271 5000 Email: [sales@chairforce.co.nz](mailto:sales@chairforce.co.nz)

